

D700.PLUS.SLIM PORTAL Curve LED Downlight

Datasheet



TRU-COLOUR®

Product Codes

Unit: D700.PLUS.SLIM	Series: CR	Colour temp. (K): 2.8K (2800K) 3K (3000K) 4K (4000K) 6K (6000K) 1.8K.3K (1800K-3000K) (Nightshift) 2.8K.6K (2800K-6000K) (Dayshift)	Beam Angle (°): 11 (Very Narrow) 36 (Medium-Narrow)	Filters: - (No Filter) HC (Honeycomb)	Inner Colour: B (BLACK) W (WHITE) RALXXXX (Custom Colour)
Control: PH (Phase Dimming) DA (DALI) ZG (ZIGBEE 3.0) CS (CASAMBI) 010 (0-10V)	Light Depth: - (Standard: 18mm) D (Deep: 33mm)	Style: PORTAL	Style Colour: B (BLACK) W (WHITE) RALXXXX (Custom Colour)	Generation: 4.0	

Dimensions (mm)

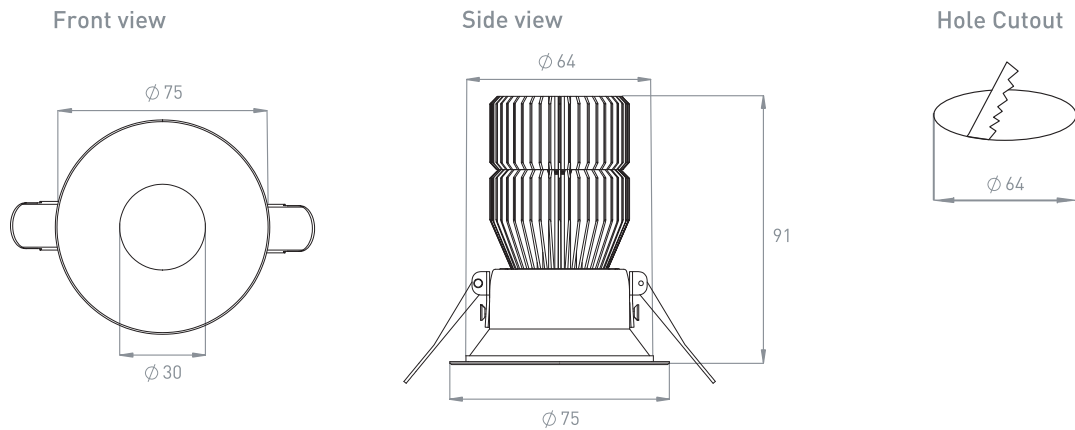

Photometrics

Photometric Diagrams

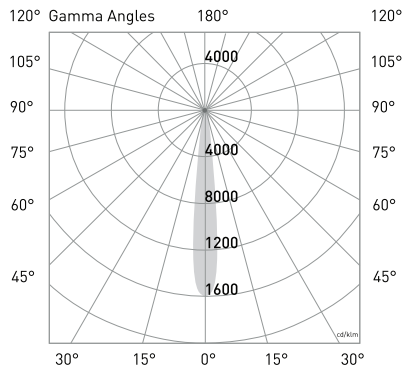

Beam Angle: 11° (Very Narrow)

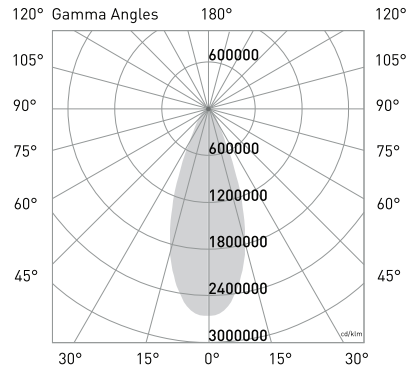

Beam Angle: 36° (Medium-Narrow)

CCT Output

CCT: 2800K
Efficacy: 74lm/W
Delivered lumen output: 735lm
CRI: 98
Standard deviation of colour
Matching (SDCM): 2 MacAdam steps

CCT: 3000K
Efficacy: 75lm/W
Delivered lumen output: 750lm
CRI: 98
Standard deviation of colour
Matching (SDCM): 2 MacAdam steps

CCT: 4000K
Efficacy: 84lm/W
Delivered lumen output: 840lm
CRI: 98
Standard deviation of colour
Matching (SDCM): 2 MacAdam steps

CCT: 6000K
Efficacy: 83lm/W
Delivered lumen output: 835lm
CRI: 98
Standard deviation of colour
Matching (SDCM): 2 MacAdam steps

CCT: 1800K-3100K
Efficacy: 75lm/W
Delivered lumen output: 750lm
CRI: 98
Standard deviation of colour
Matching (SDCM): 2 MacAdam steps

CCT: 2800K-6000K
Efficacy: 75lm/W
Delivered lumen output: 750lm
CRI: 98
Standard deviation of colour
Matching (SDCM): 2 MacAdam steps

Electrical

Input Voltage: 220-265V	Power Usage: 10W	Current: 245mA	Driver Power Factor: >0.9	Dimming: Yes	DC Cable Length: 0.3m	AC Cable Length: 0.6m
-----------------------------------	----------------------------	--------------------------	-------------------------------------	------------------------	---------------------------------	---------------------------------

Note: Dayshift (2.8K,6K) will only work with DALI DT8 or ZIGBEE driver

Physical

Gimbal Angle (°): 17°/ 360°	IP Rating: IP44	IK Rating: IK04
---------------------------------------	---------------------------	---------------------------

Operational

Ambient temp.: -28°C to 60°C	IC Rating: IC-4	UGR: <10 (36° Lens, X=4H, Y=8H)	Lifetime L70, B10: 70,000hrs (@TA85)	Lifetime L70, B50: 100,000hrs (@TA25)	Warranty: 10 Years	STC Rating: 42
--	---------------------------	---	--	---	------------------------------	--------------------------

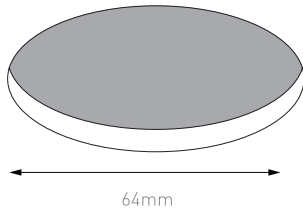

Step 1

Using a 64mm hole saw, cut a hole in the ceiling at the desired location.

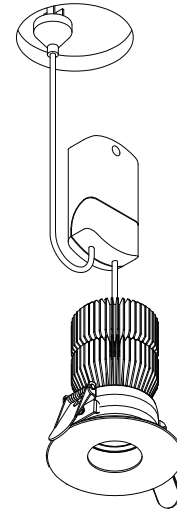

Step 2

Plug the driver into a mounted general power outlet (GPO) in the ceiling.

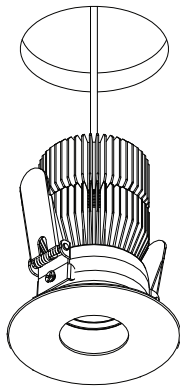

Step 3

Pull back the springs and insert the luminaire into the ceiling cavity. This luminaire can be covered and abutted with insulation.

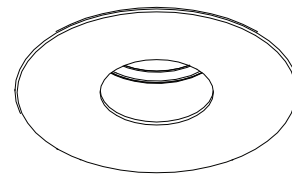

Step 4

Once the light is installed, orient the luminaire using its gimbal to focus the light as required.